

# ONKYO® SERVICE MANUAL

## COMPACT DISC PLAYER MODEL DX-5500

### Black model

BUDN, BUD	120V AC, 60 Hz
BUG	220V AC, 50Hz
BUU, BUUX	110/120/220/240V AC, 50/60Hz
BUQA, BUQB	240V AC, 50 Hz

### SAFETY-RELATED COMPONENT WARNING!!

COMPONENTS IDENTIFIED BY MARK  $\triangle$  ON THE SCHEMATIC DIAGRAM AND IN THE PARTS LIST ARE CRITICAL FOR RISK OF FIRE AND ELECTRIC SHOCK. REPLACE THESE COMPONENTS WITH ONKYO PARTS WHOSE PART NUMBERS APPEAR AS SHOWN IN THIS MANUAL.

MAKE LEAKAGE-CURRENT OR RESISTANCE MEASUREMENTS TO DETERMINE THAT EXPOSED PARTS ARE ACCEPTABLY INSULATED FROM THE SUPPLY CIRCUIT BEFORE RETURNING THE APPLIANCE TO THE CUSTOMER.

### SPECIFICATIONS

Signal readout system:	Optical non-contact
Reading rotation:	About 500~200 r.p.m. (constant linear velocity)
Linear velocity:	1.2~1.4m/s
Error correction system:	Cross interleave readsolomon code
Decoded bits:	18 bits linear
Sampling frequency:	176.4kHz (four-times oversampling)
Number of channels:	2 (stereo)
Frequency response:	5Hz~20kHz
Total harmonic distortion:	0.003% (at 1kHz)
Dynamic range:	96dB
Signal to noise ratio:	96dB
Channel separation:	96dB (at 1kHz)
Wow and Flutter:	Below threshold of measurability
Power consumption:	15 watts
Output level:	2 volts r.m.s.
Dimensions (W×H×D):	435×131×365 mm 17-1/8"×5-1/8"×14-7/16"
Weight:	8kg, 17.6 lbs.

Specifications are subject to change without notice.

**ONKYO**  
**AUDIO COMPONENTS**

# TABLE OF CONTENTS

Specifications ..... 1  
 Service procedures ..... 2  
 Note on compact disc ..... 3  
 Protection of eyes from laser beam during servicing .. 4  
 Laser warning label ..... 4  
 Caution on replacement of pickup ..... 6  
 Packing view ..... 7  
 Chassis-exploded view ..... 8  
 Parts list ..... 9  
 Mechanism-exploded view ..... 10  
 Parts list ..... 11  
 Disassembling procedures ..... 11  
 Lubrication ..... 12  
 IC block diagram and descriptions ..... 13  
 Adjustment procedures ..... 22  
 Printed circuit board view from bottom side  
     Main circuit ..... 25  
     Other pc boards ..... 29  
 Printed circuit board-parts list ..... 27  
 Block diagram ..... 31

## SERVICE PROCEDURES

### 1. How to Release the Transport Lock

To protect the optical assembly including the laser pickup from vibration related damage during shipping, this unit is equipped with a transport lock lever located on the base.

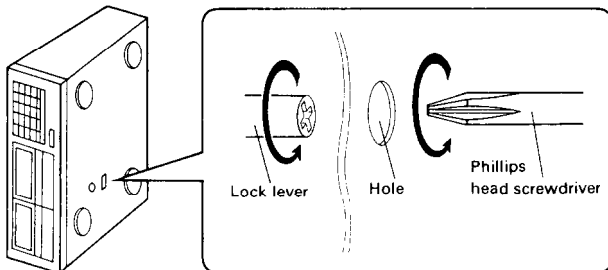

Fig. 1

- Use a screwdriver to turn the lock lever (about 90°) in the round hole in the direction of arrow ( ⤵ ).
- Before transporting the unit again, stand it with its left side facing down, and turn on the power. Wait 2-3 seconds and then turn the lock lever in the opposite direction of the arrow.

### 2. Safety-check out

After correcting the original service problem, perform the following safety check before releasing the set to the customer:

Connect the insulating-resistance tester between the plug of power supply cable and chassis.

Specifications: more than 10Mohm at 500V.

### 3. Procedures for replacement of flat packaged ICs

#### 1. Tools to be used:

- (1) **Soldering iron** . . . . Grounded soldering iron or soldering iron with leak resistance of 10 Mohms or more.

Form of soldering iron's tip:

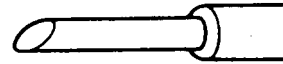

Fig. 2

- (2) **Magnifying glass** . . . for checking of finished works
- (3) **Tweezers** . . . . . for handling of IC and forming of leads
- (4) **Grounding ring** . . . . Countermeasure for electrostatic breakdown
- (5) **Nipper** . . . . . for removing defective IC
- (6) **Small brush** . . . . . for application of flux

#### 2. Work Procedures:

##### (1) Remove the defective IC

Cut all leads of the defective IC one by one using a nipper and remove the IC.

##### (2) Clean the pattern surface of the PC board.

Get rid of the remaining leads and solder.

##### (3) Check and form the leads of the new flat packaged IC to be installed.

From every lead on the new IC using a pair of tweezers, so that all of them are aligned neatly without being risen, twisted or inclined toward one side. Especially the rising portion of every lead must be formed with greatest care.

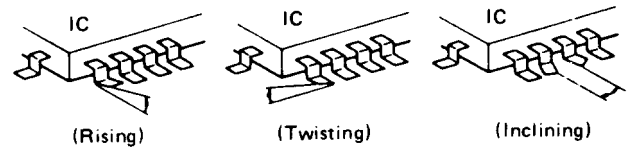
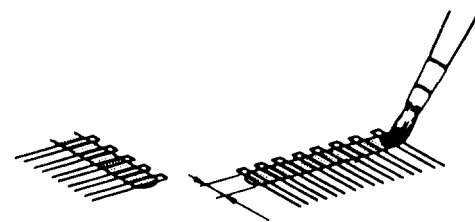

Fig. 3

##### (4) Apply flux to the PC board.

Apply flux to the pattern surface of the PC board which has been cleaned, as shown in the illustration. The area to be applied with flux is the portion of about 2.5mm in width where the IC's leads are to be soldered.

Be careful to apply minimum amount of flux required so as not to smear it on unwanted areas.



About 2.5 mm

Fig. 4

**(5) Temporarily tighten the IC**

Carefully align the pattern and IC's leads, so that the IC will be temporarily tightened to the pattern on the four leads at the corners. At this time, soldering is required, but no need to apply soldering material.

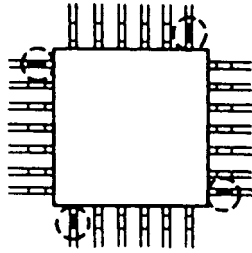

Fig. 5

**(6) Apply flux to IC's leads**

Apply flux to the areas of IC's leads where soldering is to be performed. Be careful not to smear flux on the root portion of any lead or the body of IC.

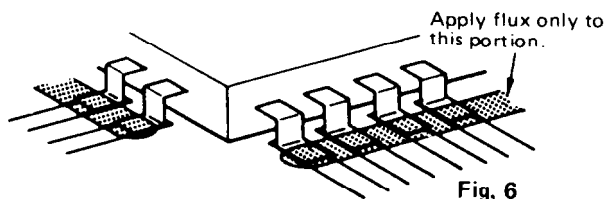

Fig. 6

**(7) Soldering**

While attaching the tip of the soldering iron to the soldering point as shown in the illustration, feed 2–5mm of soldering wire. Then, slowly move the iron in the direction indicated by the arrow in the illustration, so that the leads will be soldered to the pattern. Move the iron in the rate of approximately 1cm in 5sec. Proceed with your work while confirming a clean fillet of solder is formed on each lead, subsequent to the melting of flux.

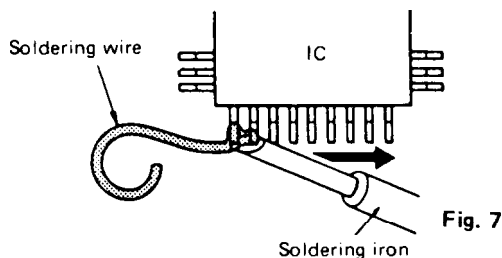

Fig. 7

**CAUTION**

- 1) If you move the iron too quickly, loose soldering is likely to result.
- 2) Be especially careful when soldering the first lead where loose soldering is most liable to be formed.

**(8) Check the results**

When soldering of all leads is finished, check the soldered portion on every lead with a magnifying glass. A tester must not be used or checking of any soldered position

**NOTE ON COMPACT DISC****• Holding Compact Discs**

Hold Compact Discs by the edges so that you do not touch

the surface of disc. Remember that the side of the disc with the "rainbow" reflection is the side containing the audio information.

Do not attach tape or paper to the label side of the disc and always be careful not to leave fingerprints on the side that is played.

**• Storing Compact Discs**

Store Compact Discs in a location protected from direct sunlight, high heat and humidity and extremely high and low temperatures. Discs should never be left in the trunk or interior of an automobile in the sun since the temperature can become very high in such a closed environment.

Always store Compact Discs in the holders in which they were sold. Never leave a disc in the player's disc holder for a long period of time.

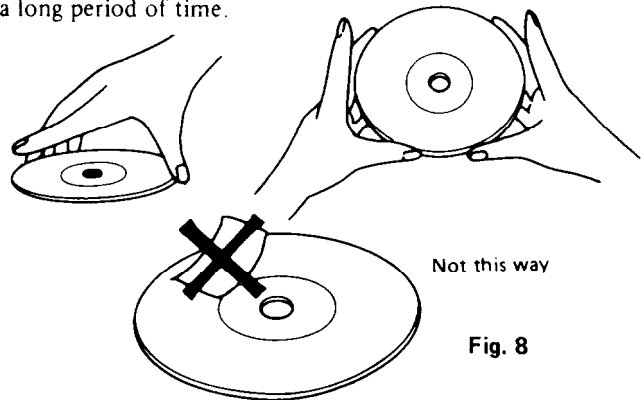

Fig. 8

**• Cleaning Compact Discs**

Before playing a disc wipe off the playing surface with a soft cloth to remove dust and other soil. Wipe the surface in straight lines from the center of the disc outward, not in a circular motion as you would with a phonograph record.

Do not use benzene, chemical cleansers or phonograph record cleaning solutions to clean Compact Discs. Also avoid static electricity prevention solutions since they can damage the surface of Compact Discs.



Fig. 9

**Problems Caused by Dew**

Dew can form inside a Compact player when it is brought from a cold environment into a warm room, when a room is rapidly heated and if a player is left in a humid environment.

This dew can prevent the laser pickup from reading the data contained in the pits in the disc surface. If the player does not operate properly because of dew, remove the disc and leave the player's power switch on for about one hour to remove all moisture.

## PROTECTION OF EYES FROM LASER BEAM DURING SERVICING

This set employs a laser. Therefore, be sure to follow carefully the instructions below when servicing.

### WARNING!!

WHEN SERVICING, DO NOT APPROACH THE LASER EXIT WITH THE EYE TOO CLOSELY. IN CASE IT IS NECESSARY TO CONFIRM LASER BEAM EMISSION, BE SURE TO OBSERVE FROM A DISTANCE OF MORE THAN 30cm FROM THE SURFACE OF THE OBJECTIVE LENS ON THE OPTICAL PICK-UP BLOCK.

## LASER WARNING LABEL

The label shown below are affixed.

### 1. Warning label



### Laser Diode Properties

- Material: GaAS/GaAlAs
- Wavelength: 780nm
- Emission Duration: continuous
- Laser output: max. 0.5mW\*

\*This output is the value measured at a distance about 1.8mm from the objective lens surface on the Optical Pick-up Block.

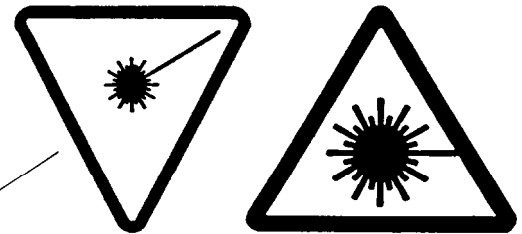

**DANGER** —INVISIBLE LASER RADIATION WHEN OPEN AND INTERLOCK FAILED OR DEFEATED. AVOID DIRECT EXPOSURE TO BEAM

**CAUTION** —HAZARDOUS LASER AND ELECTROMAGNETIC RADIATION WHEN OPEN AND INTERLOCK DEFEATED.

**ATTENTION** —RAYONNEMENT LASER ET ELECTROMAGNETIQUE DANGEREUX SI OUVERT AVEC L'ECLenchement DE SECURITE ANNULE. SN29360911

ADVARSEL: USYNLIG LASERSTRÅLING VED ÅBNING, NÅR SIKKERHEDSAFBRYDER ER UDE AF FUNKTION. UNDGÅ UDSÆTTELSE FOR STRÅLING.

Photo 1

# SCHEMATIC DIAGRAM

A  
B  
C  
D  
E  
F  
T

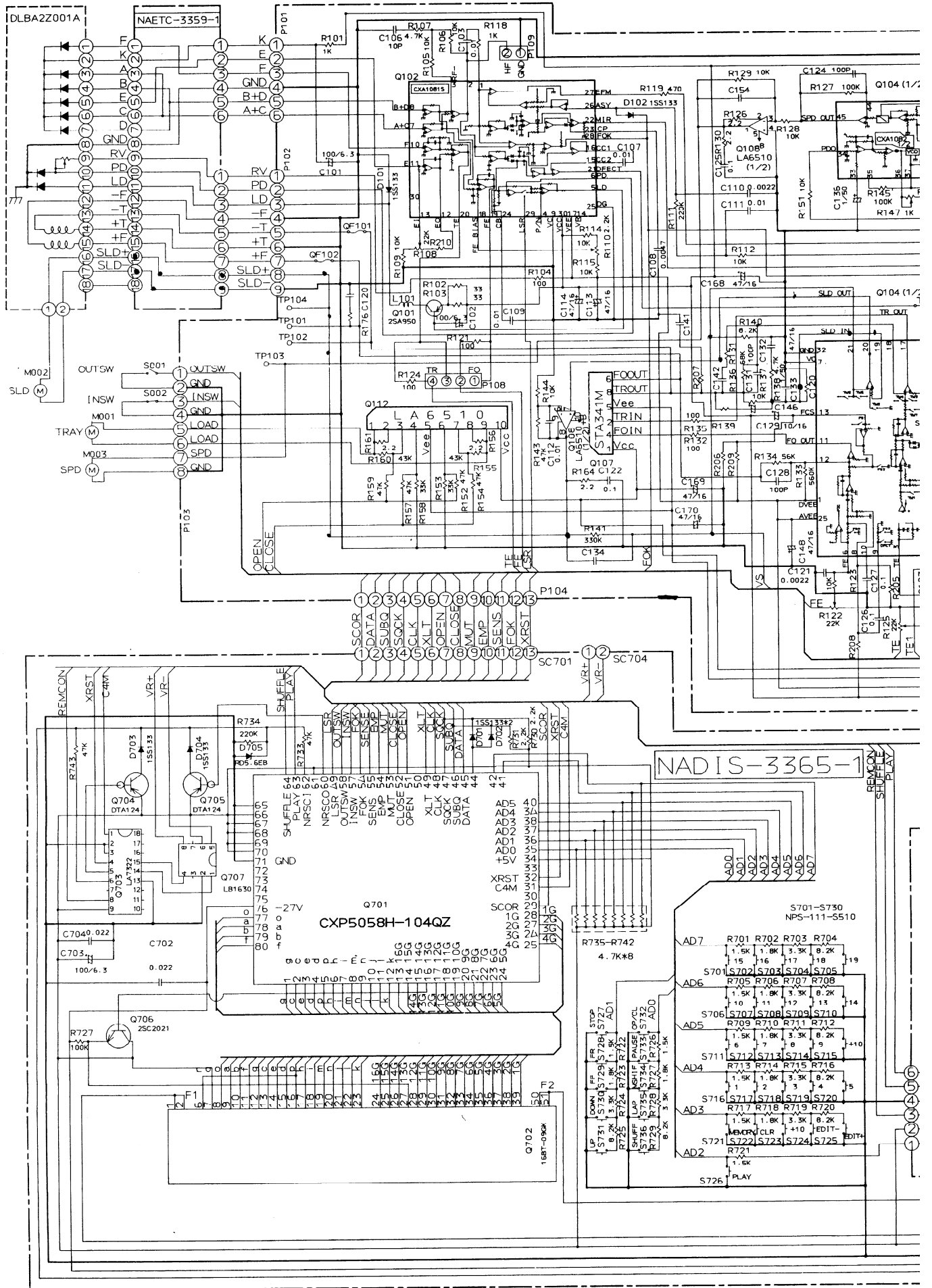



# SCHEMATIC DIAGRAM

A

B

C

D

E

F

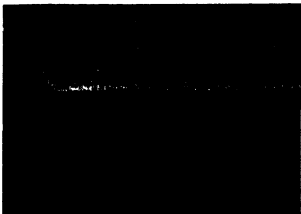
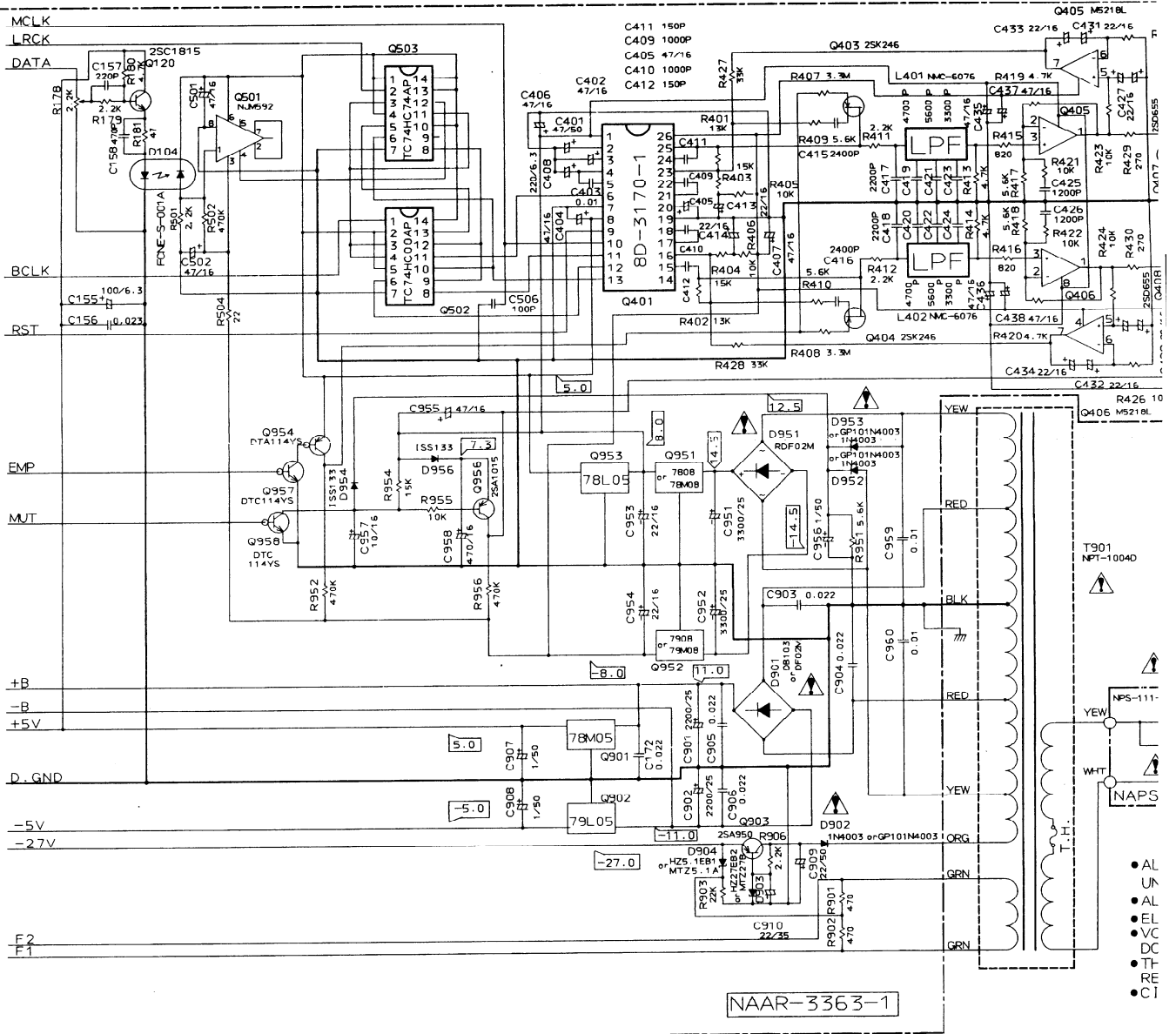

TP RF (RF signal)  
Vertical : 1V/div.  
Horizontal : 1 ms/div.  
DC, Ground: Center

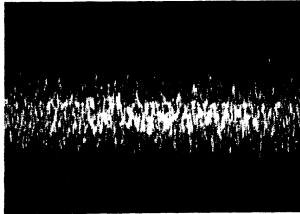

TP TO (Tracking out)  
Vertical : 0.2V/div.  
Horizontal : 0.5 ms/div.  
DC, Ground: Center

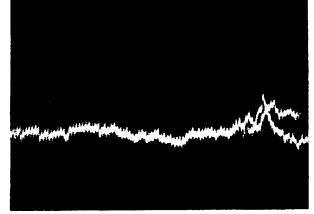

TP SPD (Spindle out)  
Vertical : 1V/div.  
Horizontal : 5 ms/div.  
DC, Ground: Center

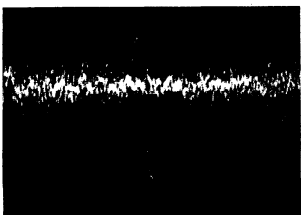

TP FO (Focus out)  
Vertical : 0.5V/div.  
Horizontal : 0.5 ms/div.  
DC, Ground: Center

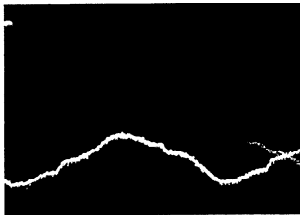

TP SLD (Slide out)  
Vertical : 2V/div.  
Horizontal : 20 ms/div.  
Top : Real  
Bottom : Storage

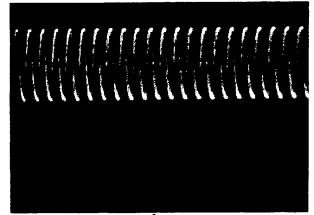

P110 PLCK  
Vertical : 0.5V/div.  
Horizontal : 0.2 μs/div.  
DC, Ground: Center

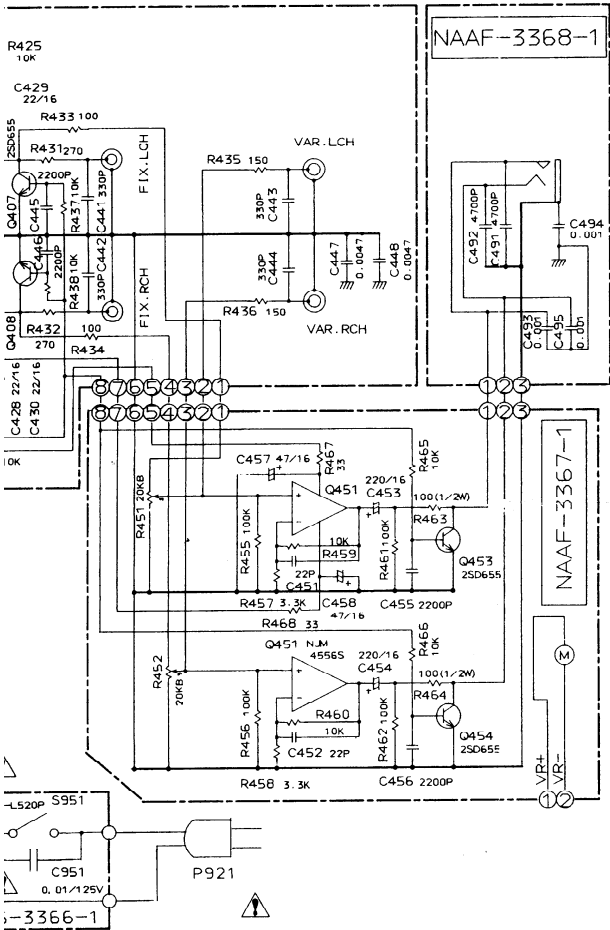

ALL RESISTORS ARE IN OHMS 1/4WATT UNLESS OTHERWISE NOTED.  
 ALL CAPACITORS ARE IN  $\mu\text{F}/50\text{V}$  UNLESS OTHERWISE NOTED.  
 ELECTROLYTIC CAPACITORS (#) ARE IN  $\mu\text{F}/\text{WV}$ .  
 VOLTAGE (MEASURED WITH V.T.V.M) MEASURED WITH  $\square$  V IS DC VOLTAGE. (NO INPUT)  
 THE COMPONENTS IDENTIFIER  $\triangle$  ARE CRITICAL FOR SAFETY. REPLACE ONLY WITH PART NUMBER SPECIFIED.  
 THIS CIRCUIT IS SUBJECT TO CHANGE FOR IMPROVEMENT.

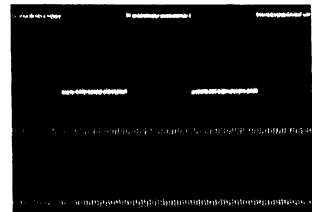

DAC UNIT Pins 13/12  
 Vertical : 2V/div.  
 Horizontal : 5  $\mu\text{s}/\text{div}$ .  
 AC



XLT  
 Vertical : 2V/div.  
 Horizontal : 0.5 ms/div.

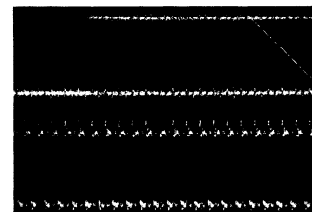

DAC UNIT Pins 13/12  
 Vertical : 2V/div.  
 Horizontal : 1  $\mu\text{s}/\text{div}$ .  
 AC

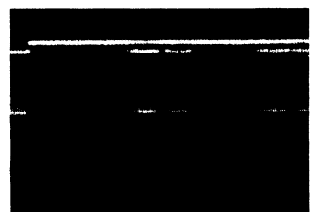

CLK  
 Vertical : 2V/div.  
 Horizontal : 50  $\mu\text{s}/\text{div}$ .  
 DC, Ground: Center

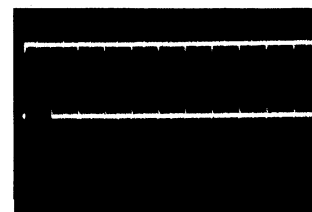

DAC Pins 11/6  
 Vertical : 2V/div.  
 Horizontal : 0.5 ms/div.  
 DC, Ground: Center



MLCK (Q117 Pin 10/Q123 Pin 8)  
 Vertical : 5V/div.  
 Horizontal : 0.1  $\mu\text{s}/\text{div}$ .

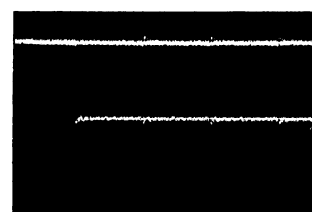

DAL  
 Vertical : 2V/div.  
 Horizontal : 0.2  $\mu\text{s}/\text{div}$ .  
 DC, Ground: Center

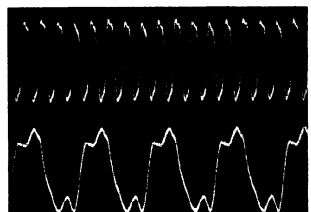

Vertical : 2V/div.  
 Horizontal: 0.1  $\mu\text{s}/\text{div}$ .  
 X'tal (Q118 Pin 4)/C4M (R164)  
 AC

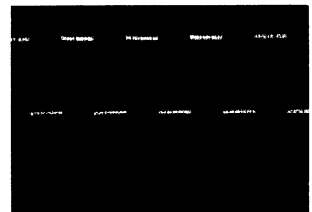

LRCK (Q109 Pin 80)  
 Vertical : 2V/div.  
 Horizontal : 10  $\mu\text{s}/\text{div}$ .  
 DC, Ground: Center

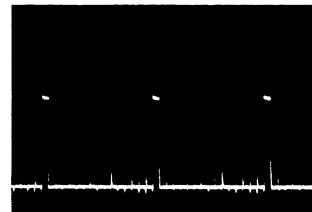

Grid  
 Vertical : 10V/div.  
 Horizontal : 1 ms/div.  
 DC, Ground: Center

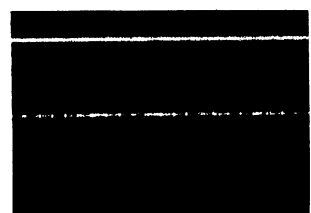

DATA (Microprocessor)  
 Vertical : 2V/div.  
 Horizontal : 0.5 ms/div.  
 DC, Ground: Center

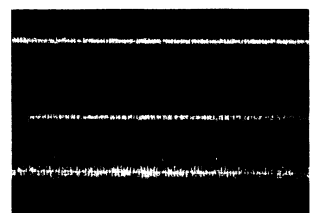

Q503 Pin 2/Pin 11  
 Vertical : 2V/0.5V  
 Horizontal : 0.5  $\mu\text{s}/\text{div}$ .

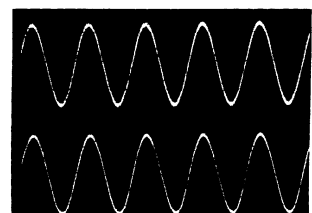

DAC OUT Pins 14/25  
 V: 2V  
 H: 0.5 ms



## 2. Certification label (UD: 120V model)

This label is located on the back panel.



Photo 2

## 3. Class 1 label (Other models)

This label is located on the back panel.

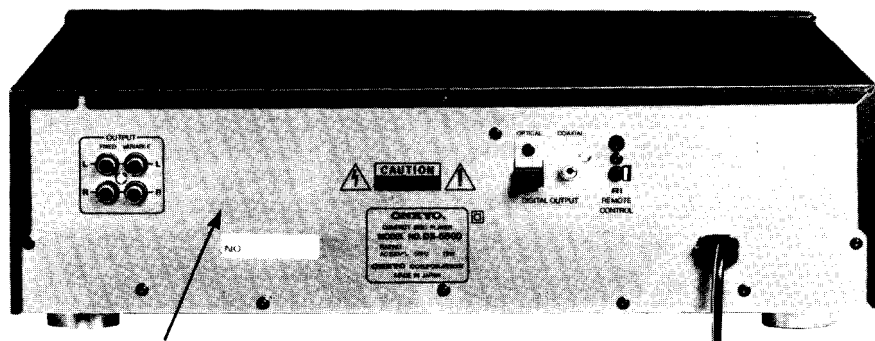
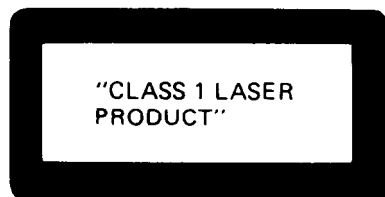

Photo 3

### ADVARSEL



Denne mærkning er anbragt på apparatets højre side og indikerer, at apparatet arbejder med laserstråler af klasse 1, hvilket betyder, at der anvendes laserstråler af svageste klasse, og at man ikke på apparatets yderside kan blive udsat for utilladelig kraftig stråling.

**APPARATET BØR KUN ÅBNES AF FAGFOLK MED SÆRLIGT KENDSKAB TIL APPARATER MED LASERSTRÅLER!**

Indvendigt i apparatet er anbragt den her gengivne advarselsmærkning, som advarer imod at foretage sådanne indgreb i apparatet, at man kan komme til at udsætte sig for laserstråling.

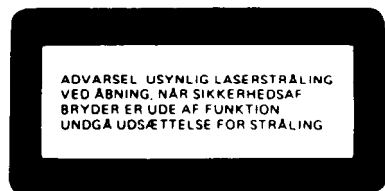

**VAROITUS!** Laite sisältää laserdiodin, joka lähettää (näkymätöntä) silmille vaarallista lasersäteilyä.

Fig. 10

## CAUTION ON REPLACEMENT OF PICKUP

The laser diode in the optical pick-up block is so sensitive to static electricity, surge current and etc. that the components are liable to be broken down or its reliability remarkably deteriorated.

During repair, carefully take the following precautions. (The following precautions are included in the service parts).

### PRECAUTIONS

#### 1. Ground for the work-desk.

Place a conductive sheet such as a sheet of copper (with impedance lower than  $10^6 \Omega$ ) on the work-desk and place the set on the conductive sheet so that the chassis.

#### 2. Grounding for the test equipment and tools.

Test equipments and toolings should be grounded in order that their ground level is the same the ground of the power source.

#### 3. Grounding for the human body.

Be sure to put on a wrist-strap for grounding whose other end is grounded.

Be particularly careful when the workers wear synthetic fiber clothes, or air is dry.

#### 4. Select a soldering iron that permits no leakage and have the tip of the iron well-grounded.

#### 5. Do not check the laser diode terminals with the probe of a circuit tester or oscilloscope.

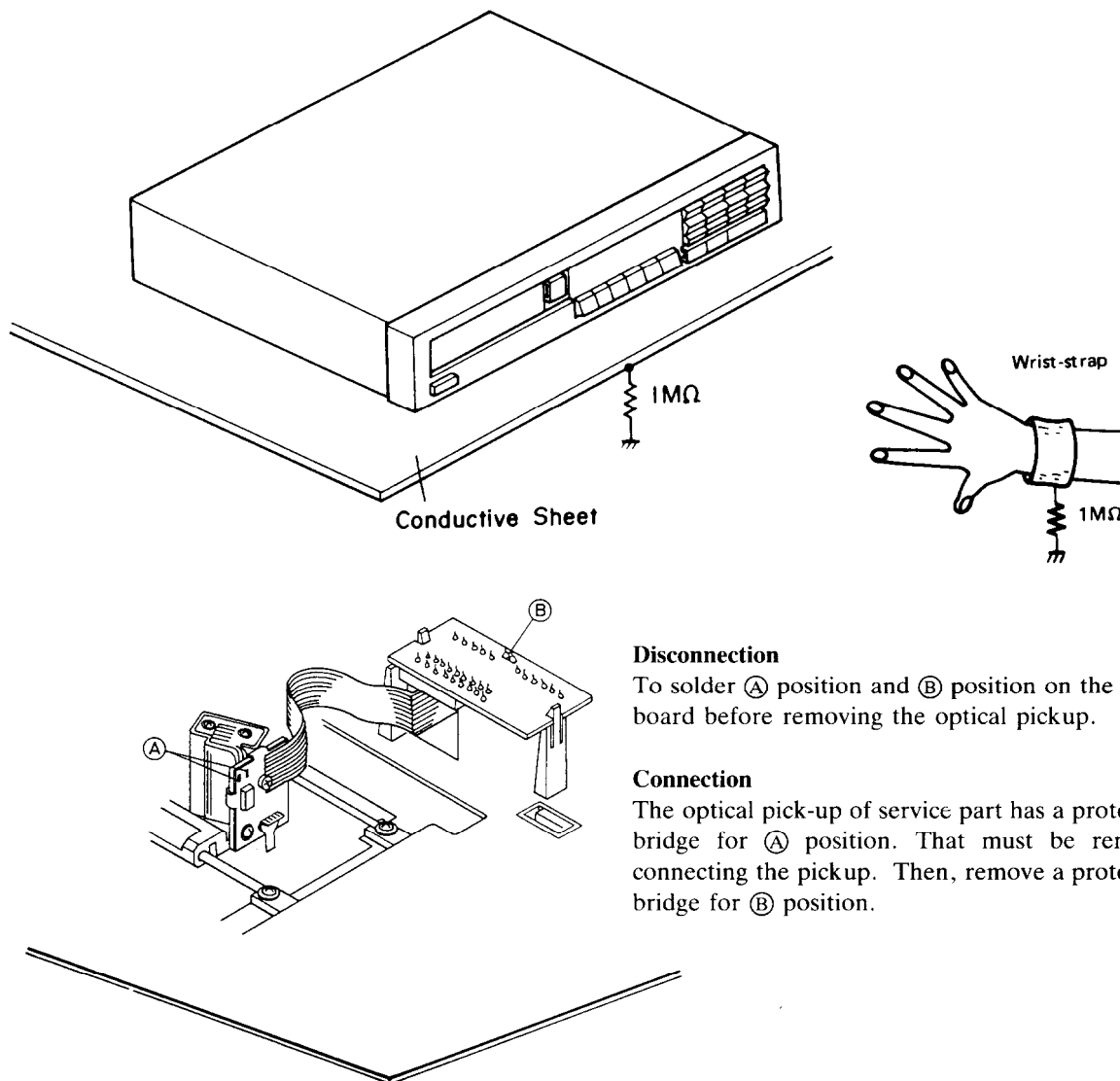

Fig. 11

#### Disconnection

To solder (A) position and (B) position on the terminal PC board before removing the optical pickup.

#### Connection

The optical pick-up of service part has a protective solder bridge for (A) position. That must be removed after connecting the pickup. Then, remove a protective solder bridge for (B) position.

# PACKING VIEW

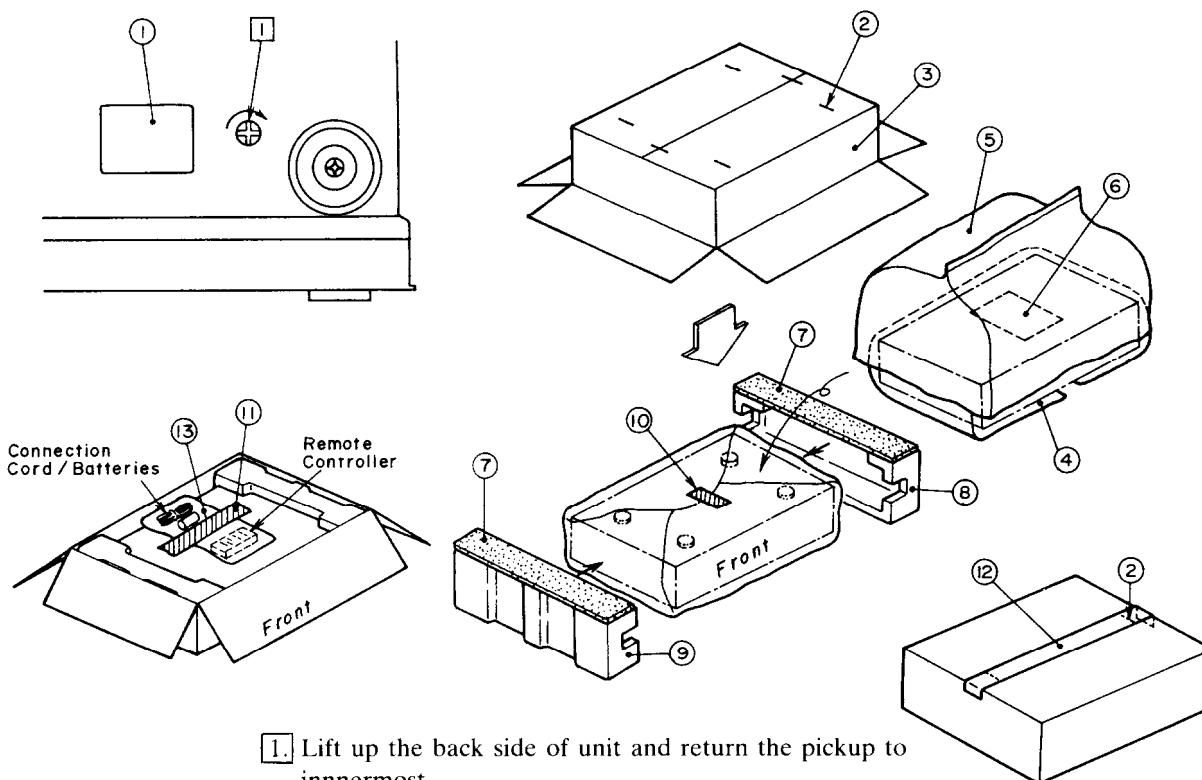

1. Lift up the back side of unit and return the pickup to innermost.

Use a screwdriver to turn the lock lever (about 90°) in the round hole in the direction of arrow. (Clockwise)

REF. NO.	PART NO.	DESCRIPTION
1	29361123	Label
2	282301	Sealing hook
3	29051748	Master carton box
	29051758A	Master carton box (PX)
4	29095012-1	500×800mm, Protection sheet
5	29100105	550×680mm, Poly-vinyl bag
6	29361047	Label, sheet
7	29095572	Sheet
8	29091264A	Pad L
9	29091265A	Pad R
10	261504	Adhesive tape
11	29110071	Damplon tape
12	260012	Damplon tape
13		Accessary bag ass'y
	29341301	Instruction manual (D/PX)
	29341348	Instruction manual (G/U)
	2010097	Connection cord
	24140028	RC-122C, Remote controller
	3010054	UM-3, Two batteries
	2010169	Cord RI
	29365019	Warranty card (N)
	29365021	Warranty card (PX)
	29358002F	Service station list (N/PX)
	25055040	CV-K-2, Conversion plug (U)
	25055251	CV-CP, Conversion plug (PX)
	29100097	Poly-vinyl bag
	29091309	Pad, tray panel

NOTE: (D): Only 120V model  
 (G): Only 220V/240V models  
 (U): Only worldwide model  
 (PX): Only PX model  
 (N): Only U.S.A. model



## PARTS LIST

REF. NO.	PART NO.	DESCRIPTION	REF. NO.	PART NO.	DESCRIPTION	
A1	27100170A	Chassis	P801	253112A	AS-UC-4# 18, Power supply cord (D/PX)	
A2	27100169A	Chassis U		253148 or	AS-CEE 250V 2.5A,	
A3	27130542	Bracket C		253150	Power supply cord (G/W)	
A4	27130543B	Bracket L		253118	AS-SAA, Power supply cord (OA)	
A5	27141311	Bracket T		253104	Power supply cord (OB)	
A6	27121162	Back panel (D)		25065168	HXW0131-01-060, Voltage selector switch (W)	
	27121163	Back panel (G)	S902			
	27121164	Back panel (W/PX)		2300341	NPT-1004D, Power transformer (D)	
	27121205	Back panel (QA/OB)		2300342	NPT-1004G, Power transformer (G)	
A7	27175011C	Leg (Cushion)	T901	2300343	NPT-1004ADGO, Power transformer (W/PX)	
A8	28140873	Cushion		2300344	NPT-1004Q, Power transformer (QA/OB)	
A9	27300750	Strainrelief	U1	1H048563-1	NAAR-3363-1, Main circuit pc board ass'y (D)	
A10	27273101A	Joint, power		1H048563-1A	NAAR-3363-1A, Main circuit pc board ass'y (G/W/QA/OB/PX)	
A11	27270278	Spacer		1H048564-1	NADG-3364-1, Opto./digital output pc board ass'y	
A12	27300833	WS-2NS, Clamper		1H048565-1	NADIS-3365-1, Display circuit pc board ass'y	
A13	28140903	Cushion		1H048566-1	NAPS-3366-1, Power switch pc board ass'y	
A14	27270214A	Spacer		1H048567-1	NAAF-3367-1, Headphone amplifier pc board ass'y	
A15	27270212	Spacer		U6	1H048568-1	NAAF-3368-1, Headphone terminal pc board ass'y
A16	28133202	Back plate		U7	1H048569-1	NASW-3369-1, Switch pc board ass'y
A17	870060	W3×15, Flat washer		W1	260208	Binder
A18	27267558-1	Guide				
A19	27141281	Bracket				
A20	830440109	4TTT+10C (BH), Tapping screw				
A21	8343430108	3TTS+10B (BC), Tapping screw				
A22	8343430088	3TTS+8B (BC), Tapping screw				
A23	831130088	3TTW+8B, Tapping screw				
A24	834230108	3TTS+10B (Ni), Nickel screw				
A25	8343430068	3TTS+6B (BC), Tapping screw				
A26	8384330088	3TTB+8B (BC), Tapping screw				
A27	27301184	Lock pin				
A28	27141310	Bracket, rail				
A29	27141309A	Bracket				
A30	28140918	Cushion				
A31	27110433	Front bracket ass'y				
A41	28184401	Top cover —				
A42	8384440089	4TTB+8C (BC), Tapping screw				
A43	8344330088	3TTS+8B (BC), Tapping screw				
A44	28140408	t3×10×36, Cushion				
A51	1H048121	Front panel ass'y				
A52	28191477	Clear plate				
A53	27210987	Panel, door (Tray panel)				
A55	27175153	Leg				
A57	84643008	3HSB×8FN (BC), Special bolt				
A58	8344330088	3TTS+8B (BC), Tapping screw				
A59	8334330080	3TTP+8P (BC), Tapping screw				
A60	27270255	Spacer				
A81	28323433	Knob				
A82	28323152	Knob MODE				
A83	27301187	Cushion L				

NOTE: (D): Only 120V model  
(G): Only 220V model  
(W): Only Worldwide model  
(PX): Only PX model  
(QA): Only Australian model  
(OB): Only British model

NOTE: THE COMPONENTS IDENTIFIED BY MARK  
▲ ARE CRITICAL FOR RISK OF FIRE AND  
ELECTRIC SHOCK. REPLACE ONLY WITH  
PART NUMBER SPECIFIED.

# MECHANISM-EXPLODED VIEW

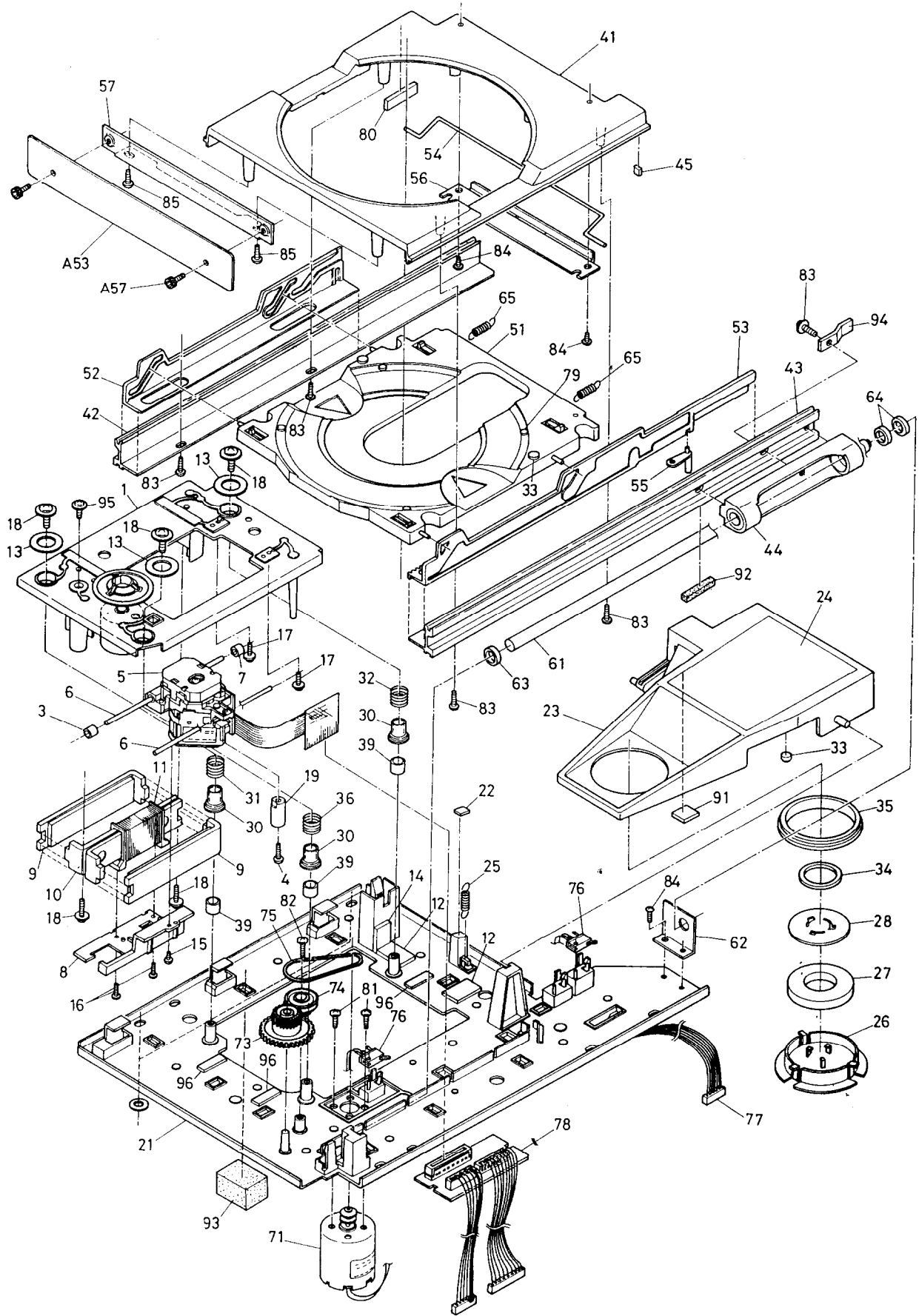

## PARTS LIST

REF. NO.	PART NO.	DESCRIPTION	REF. NO.	PART NO.	DESCRIPTION
1	1H048901	Spindle motor ass'y	42	27301135	Rail L
3	27270264-1	Spacer	43	27301136	Rail R
4	82542010	2B+10F(BC), Binding screw	44	27301126	Guide bearing
5	(24110003)	DLBA2Z2001A, Optical pickup	45	28140892	Cushion T
6	27260286	Shaft	51	27301137B	Disc plate
7	27270264-1	Spacer	52	27301138	Cam plate L
8	27301129B	Plate	53	27301139A	Cam plate R
9	28181020	Magnet ass'y	54	27260280A	Shaft
10	27301152	York ass'y	55	27301140A	Stopper
11	24502236A	Coil	56	27301141A	Plate
12	28140912	Cushion A	57	27141275	Bracket
13	28140913	Cushion B	61	27260281A	Shaft
14	28140914	Cushion C	62	27141274	Bracket
15	82542006	2B+6F(BC), Binding screw	63	27270265A	Spacer
16	833420068	2TTP+6B(BC), Tapping screw	64	27270276	Spacer
17	831430100	3TTW+10P(BC), Tapping screw	65	27180418	Spring
18	801414	Special screw	71	1H048902	Disc motor ass'y
19	27301179	Weight PU	73	27301142	Pulley gear
21	27100166C	Chassis L	74	27301143A	Flat wheel
22	28140891	Cushion A	75	27301162	Rubber belt
23	27301131B	Arm	76	25065322	NMS-1214, Microswitch
24	29360911	Label LASER 3	77	2000888	Socket ass'y
25	27180402	Spring	78	1H048559-1	NAETC-3359-1, Terminal pc board ass'y
26	27301132A	Cap CH	79	27301180	Cushion
27	28181019A	Magnet CH	81	82143004	3P+4FN(BC), Pan head screw
28	27301133	York CH	82	831126060	2.6TTW+6P, Tapping screw
30	27301134	Cushion rubber	83	838430088	3TTB+8B(BC), Tapping screw
31	27180403A	Spring F	84	834430068	3TTS+6B(BC), Tapping screw
32	27180404B	Spring R	85	834430088	3TTS+8B(BC), Tapping screw
33	28140860	Cushion	91	28140908-	Cushion K
34	27270277	Spacer	92	28140909	Cushion L
35	27301172	Cushion rubber	93	28140910	Cushion F
36	<del>28180417</del>	Spring G	94	27141317	Bracket, switch
37	27301182	Cushion L	95	834440168	4TTS+16B(BC), Tapping screw
39	28140917	Tube	96	28140911	Cushion P
41	27301124	Disc tray			

## DISASSEMBLING PROCEDURES

### Top cover

Remove a screw holding the back panel and top cover.  
Remove the four screws holding the top cover and chassis.

### Main circuit PC board

Remove the top cover.  
Remove the eight screws holding the back panel and chassis.  
Remove a screw holding the bracket C and opto./digital output PC board.  
Remove four screws holding the main PC board and chassis.

### Tray panel

Use a hexagon wrench (2.5mm), remove the two hexagon bolt holding the tray panel and mechanical chassis.

### Mechanism ass'y

Remove the tray panel.  
Remove the four screws holding the mechanism and chassis.

**Caution:** When disconnect the sockets P101 and P102 on the main circuit PC board, solder the B point on the terminal PC board or the A point on the pickup. (Refer page 6) After remove the flexible PC board of pickup from terminal PC board, remove the terminal PC board.

# LUBRICATION

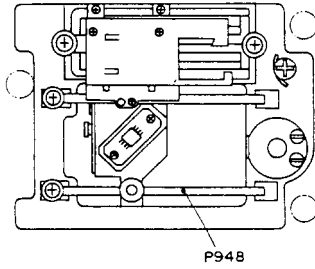
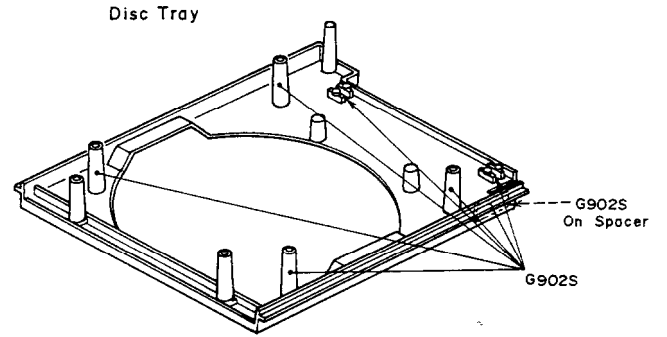
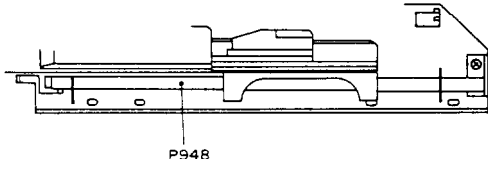
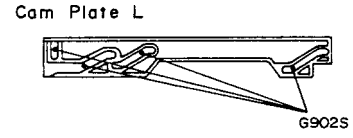
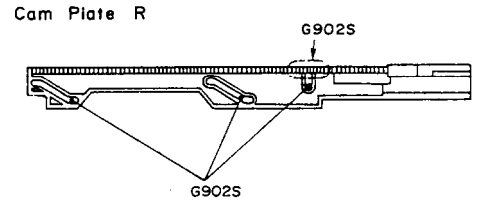
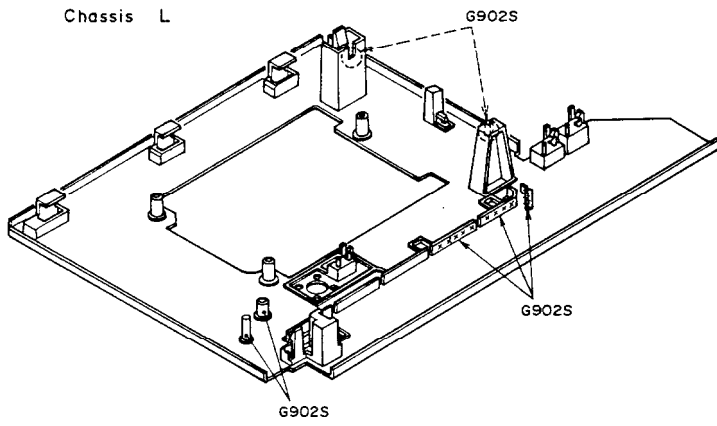



## ADJUSTMENT PROCEDURES

### Instruments required

Dual trace oscilloscope, Frequency counter, AF oscillator, Test disc (SONY YEDS-18), AC voltmeter, Jitter meter, and Socket P4(Part no. 25050138)

### 1. VCO frequency adjustment

Connect the frequency counter to terminal P110.

Turn the power switch to ON.(No load the disc.)

Adjust R147 until the frequency counter reading becomes  $4322 \pm 5\text{kHz}$ .

After adjustment, disconnect the frequency counter.

### 2. Focus offset adjustment

Load the test disc YEDS-18 on the tray and play the track 2.

Connect the oscilloscope or jitter meter to terminal P109.  
(Oscilloscope)

Adjust R110 until a clear trace of waveform pattern as shown photo 1 appear on the oscilloscope.

When the amount of jitter is broad, set R110 to mechanical center.

(Jitter meter)

Adjust R110 until the jitter meter reading becomes minimum.(Less than 10ns.)

After adjustment, disconnect the oscilloscope or jitter meter.

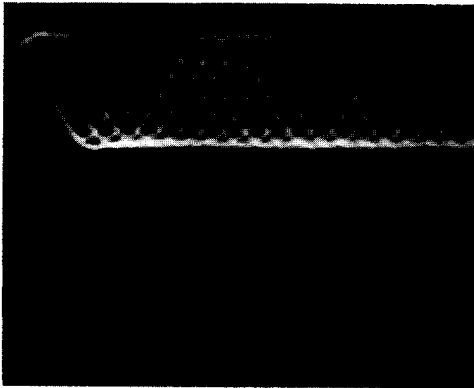
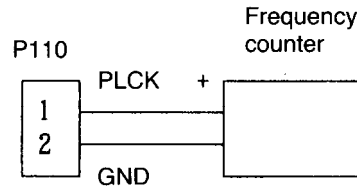
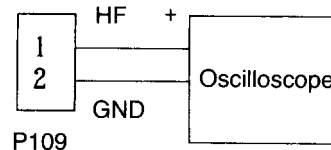
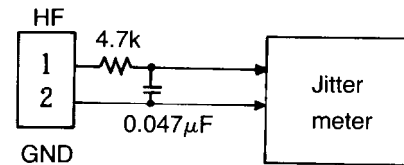

Photo 1



Oscilloscope range  
Vertical : 0.5V/div.  
Horizontal : 0.2  $\mu\text{s}/\text{div}$ .  
DC, Ground: Center



### 3. Tracking offset adjustment

Connect the short clip between TP105 and Ground of digital section.

Turn R125 to minimum position.(Counter clockwise)

Connect the oscilloscope between pin 3 (TR) of P108 and pin 2 (GND) of P109.

Adjust R108 until the center of tracking error signal on the oscilloscope becomes GND level.

Turn R125 to the mechanical center.

After adjustment, disconnect the oscilloscope and short clip.

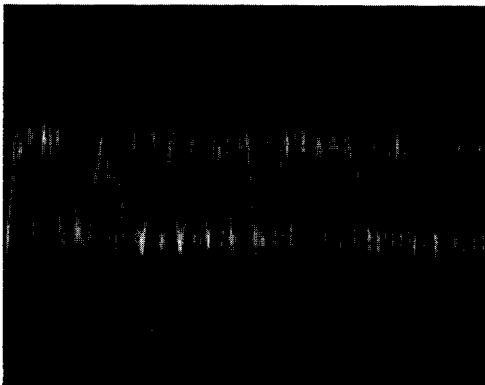
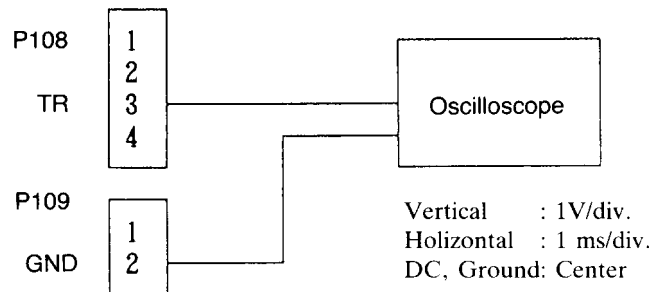

Photo 2



Vertical : 1V/div.  
Horizontal : 1 ms/div.  
DC, Ground: Center

#### 4. Focus gain adjustment

Set the output of AF oscillator to 800Hz, 1~1.5Vp-p.

Play the track 2 of test disc.

Connect the oscilloscope and the AF oscillator as shown below.

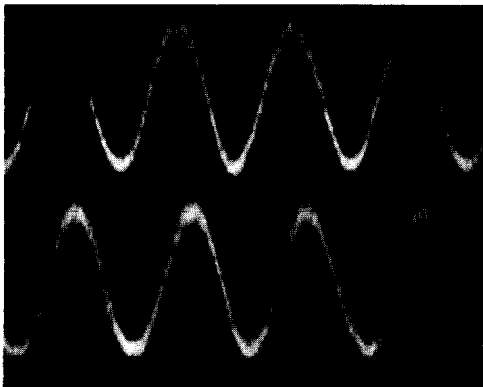
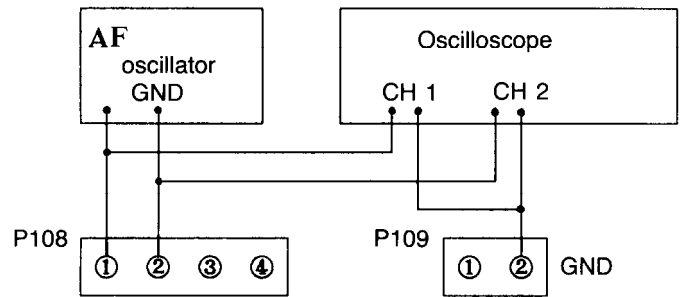

Photo 3

Adjust R122 until 800Hz components of channels 1 and 2 on oscilloscope become same level.

After adjustment, disconnect the AF oscillator and the oscilloscope.



Vertical : 0.5V/div.  
Horizontal: 0.5 ms/div.

#### 5. Tracking gain adjustment

Set the output of AF oscillator to 1.2kHz, 1~1.5Vp-p.

Play the track 2 of test disc.

Connect the oscilloscope and the AF oscillator as shown below.

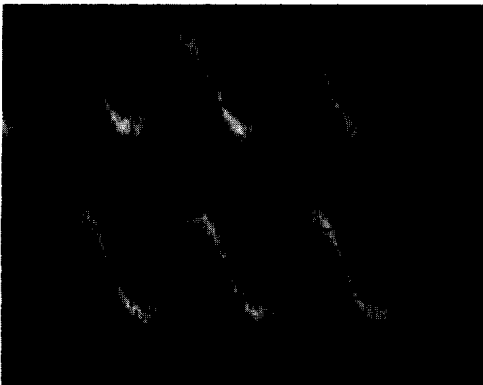
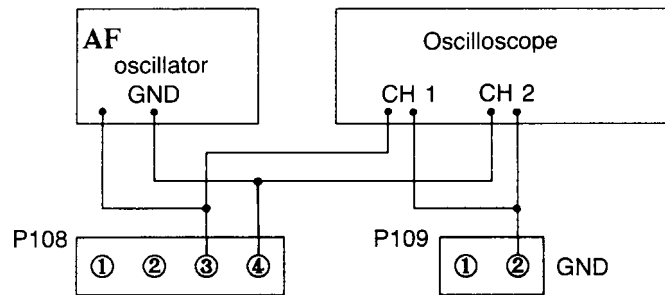

Photo 4

Adjust R125 until 1.2kHz components of channels 1 and 2 on oscilloscope become same level.

After adjustment, disconnect the AF oscillator and the oscilloscope.



Vertical : 0.5V/div.  
Horizontal: 0.2 ms/div.

#### 6. Opto. transmitter system adjustment

Connect the oscilloscope to test point TP401.

Play the track 2 of test disc.

Adjust R178 until the cross point of data waveform as shown photo 5 becomes on the top side.

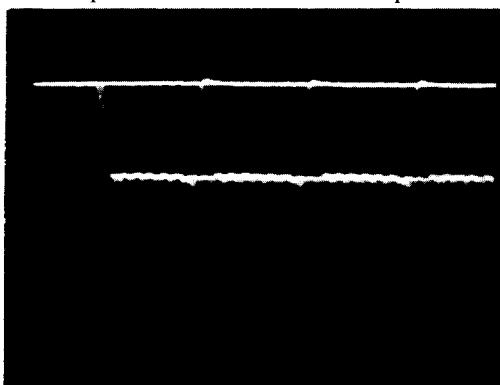
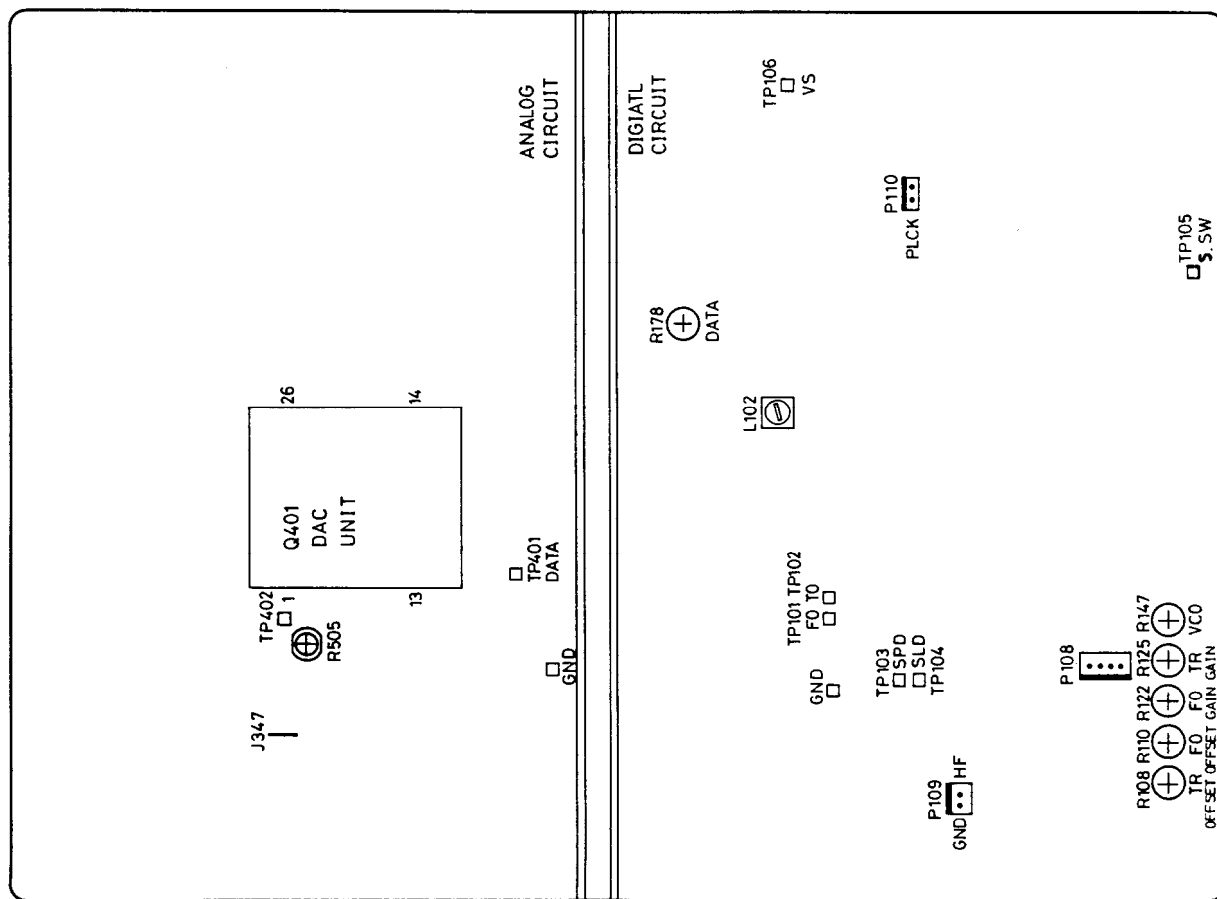

Photo 5

Vertical : 2V/div.  
Horizontal : 0.2  $\mu$ s/div.  
DC, Ground: Center



Adjustment point

### 7. DAC power supply voltage adjustment

Connect the DC voltmeters to J347 and TP402.

(Connect the DC voltmeter to the leg of semi-fixed resistor when TP402 is not on the pc board.)

(Refer adjustment point)

Adjust R505 until the voltage discrepancy between TP402 and J347 is 0.1V.(TP402>J347)

# PRINTED CIRCUIT BOARD-PARTS LIST

## MAIN CIRCUIT PC BOARD (NAAR-3363-1/1A)

CIRCUIT NO.	PART NO.	DESCRIPTION	CIRCUIT NO.	PART NO.	DESCRIPTION
					<b>Capacitors</b>
			C101, C102	354721019	100 $\mu$ F, 6.3V, Elect.
			C103, C107	371121034	0.01 $\mu$ F $\pm$ 5%, 50V, Mylar
			C108	371124724	4700pF $\pm$ 5%, 50V, Mylar
			C109	371121034	0.01 $\mu$ F $\pm$ 5%, 50V, Mylar
			C110	371122224	2200pF $\pm$ 5%, 50V, Mylar
			C111, C112	371121034	0.01 $\mu$ F $\pm$ 5%, 50V, Mylar
			C113, C114	354721019	100 $\mu$ F, 6.3V, Elect.
			C121	371122224	2200pF $\pm$ 5%, 50V, Mylar
			C122	371121044	0.1 $\mu$ F $\pm$ 5%, 50V, Mylar
			C123	371122234	0.022 $\mu$ F $\pm$ 5%, 50V, Mylar
			C125-C127	371121044	0.1 $\mu$ F $\pm$ 5%, 50V, Mylar
			C129	354741009	10 $\mu$ F, 16V, Elect.
			C130	371123334	0.033 $\mu$ F $\pm$ 5%, 50V, Mylar
			C132	354744709	47 $\mu$ F, 16V, Elect.
			C133	354780339	3.3 $\mu$ F, 50V, Elect.
			C135	371121034	0.01 $\mu$ F $\pm$ 5%, 50V, Mylar
			C136	354780109	1 $\mu$ F, 50V, Elect.
			C138	354744709	47 $\mu$ F, 16V, Elect.
			C139	354782299	0.22 $\mu$ F, 50V, Elect.
			C140, C180	371121034	0.01 $\mu$ F $\pm$ 5%, 50V, Mylar
			C142	371121044	0.1 $\mu$ F $\pm$ 5%, 50V, Mylar
			C146	354780229	2.2 $\mu$ F, 50V, Elect.
			C148	354721019	100 $\mu$ F, 6.3V, Elect.
			C149	354781099	0.1 $\mu$ F, 50V, Elect.
			C150	371122234	0.022 $\mu$ F $\pm$ 5%, 50V, Mylar
			C151	371122224	2200pF $\pm$ 5%, 50V, Mylar
			C152, C155	354721019	100 $\mu$ F, 6.3V, Elect.
			C162	352942206	22 $\mu$ F, 16V, Non-polar elect.
			C166	354744709	47 $\mu$ F, 16V, Elect.
			C168-C171	354744709	47 $\mu$ F, 16V, Elect.
			C173, C175	354744709	47 $\mu$ F, 16V, Elect.
			C177	354744709	47 $\mu$ F, 16V, Elect.
			C179	354780479	4.7 $\mu$ F, 50V, Elect.
			C401	354721019	100 $\mu$ F, 6.3V, Elect.
			C402	354744709	47 $\mu$ F, 16V, Elect.
			C403	371121034	0.01 $\mu$ F $\pm$ 5%, 50V, Mylar
			C404, C405	354744709	47 $\mu$ F, 16V, Elect.
			C406, C407	391242217	220 $\mu$ F, 16V, Elect.
			C408	354722219	220 $\mu$ F, 6.3V, Elect.
			C409, C410	373301024	1000pF $\pm$ 5%, 125V, PP
			C411, C412	373301514	150pF $\pm$ 5%, 125V, PP
			C413, C414	354742209	22 $\mu$ F, 16V, Elect.
			C415, C416	371122424	2400pF $\pm$ 5%, 50V, Mylar
			C417, C418	371122224	2200pF $\pm$ 5%, 50V, Mylar
			C419, C420	371124724	4700pF $\pm$ 5%, 50V, Mylar
			C421, C422	371125624	5600pF $\pm$ 5%, 50V, Mylar
			C423, C424	371123324	3300pF $\pm$ 5%, 50V, Mylar
			C425, C426	371121224	1200pF $\pm$ 5%, 50V, Mylar
			C427-C434	391242207	22 $\mu$ F, 16V, Elect.
			C435-C438	354744709	47 $\mu$ F, 16V, Elect.
			C441-C444	373303314	330pF $\pm$ 5%, 125V, PP
			C445, C446	371122224	2200pF $\pm$ 5%, 50V, Mylar
			C447, C448	371124724	4700pF $\pm$ 5%, 50V, Mylar
			C501-C503	354744709	47 $\mu$ F, 16V, Elect.
			C505	354762219	220 $\mu$ F, 35V, Elect.
			C901, C902	352752229	2200 $\mu$ F, 25V, Elect.
			C907, C908	354780109	1 $\mu$ F, 50V, Elect.
			C909	354782209	22 $\mu$ F, 50V, Elect.
			C910	354762209	22 $\mu$ F, 35V, Elect.
			C911, C961	375101045	0.1 $\mu$ F $\pm$ 10%, 125V, Plastic
			C951, C952	352753329	3300 $\mu$ F, 25V, Elect.
			C953, C954	354742219	220 $\mu$ F, 16V, Elect.
			C955, C956	354780109	1 $\mu$ F, 50V, Elect.
			C957	354741009	10 $\mu$ F, 16V, Elect.
			C958	354744719	470 $\mu$ F, 16V, Elect.
			C959, C960	379121035	0.01 $\mu$ F $\pm$ 10%, 50V, Plastic
Q102	22240180	CXA1081S			
Q103	22240018	M51943ASL			
Q104	22240181	CXA1082AS			
Q107	22240168	STA341M-L			
Q108	22240034	LA6510			
Q109	22240129	CXD1125QZ			
Q110	22240178 or 22240118	CXK5816SPS-15L or LC3517AS-15			
Q112	22240034	LA6510			
Q114	222956	NJM2068DD			
Q115	222850381	HD14538BP			
Q116	222740745	74HC74P			
Q117	222740865	74HC86P			
Q118	222755	74HCU04P			
Q121, Q122	222740745	74HC74P			
Q123	222740005	74HC00P			
Q401	222076A	8D-3170-1(DAC unit)			
Q405, Q406	222652	M5218L			
Q501	22240035	NJM592D8			
Q502	222740005	74HC00P			
Q503	222740745	74HC74P			
Q901	222780052	78M05			
Q902	222790053	79L05			
Q951	222780085MIT	M5F78M08L			
Q952	222790085MIT	M5F79M08L			
Q953	222780053	78L05			
		<b>Transistors</b>			
Q101	2211503 or 2211504	2SA950-O or 2SA950-Y			
Q119, Q120	2211254 or 2211255	2SC1815-Y or 2SC1815-GR			
Q129	221281	DTC114YS			
Q403, Q404	2212304 or 2211945	2SK381-D or 2SK246-GR			
Q407, Q408	2211705 or 2211706	2SD655-E or 2SD655-F			
Q903	2211503 or 2211504	2SA950-O or 2SA950-Y			
Q954	2213090	DTA114YS			
Q956	2211454 or 2211455	2SA1015-Y or 2SA1015-GR			
Q957, Q958	221281	DTC114YS			
		<b>Diodes</b>			
D101-D103	223163	1SS133			
D105	223163	1SS133			
D901	22380018 or 223892	DB103 or DF02M			
D902, D952	223880 or	GP101N4003 or			
D953	223896	1N4003F			
D903	224652702 or 224452702	HZ27EB2 or MTZ27B			
D904	224650511 or 224450511	HZ5.1EB1 or MTZ5.1A			
D951	22380013	RDF02M			
D954, D956	223163	1SS133			
		<b>Photo coupler</b>			
D104	24120005 or 24120006	FCNE-S-001A or FCNE-S-001B			
		<b>X'tal</b>			
X101	3010112	KD6586FFB			
		<b>Coils</b>			
L101	231023	NCH-1062			
L102	232136 or 232143	NSRF-2046 or NSRF-2047			
L401, L402	232151	NMC-6076			

CIRCUIT NO.	PART NO.	DESCRIPTION
	<b>Resistors</b>	
R108	5210066	N06HR22KBD, Semi-fixed
R110	5210060	N06HR2.2KBD, Semi-fixed
R122, R125	5210066	N06HR22KBD, Semi-fixed
R147	5210058	N06HR1KBD, Semi-fixed
R178	5210060	N06HR2.2KBD, Semi-fixed
R505	5210061 or 5210117	N06HR3.3KBD or N06HR3KBC, Semi-fixed
	<b>Plugs</b>	
P101	25055136	NPLG-6P120
P102	25055139	NPLG-9P123
P103	25055154	NPLG-10P138
P104	25055157	NPLG-13F141
P105	25055190	NPLG-9P174
P106	25055146	NPLG-2P130
P107	25055150	NPLG-6P134
P108	25055045	NPLG-4P33
P109, P110	25055038	NPLG-2P29
P402	25055152	NPLG-8P136
	<b>Terminal</b>	
P401	25045236	NPJ-4PDBL110
	<b>Radiators</b>	
	27160176	RAD56
	27160145	RAD51
	<b>Socket</b>	
J5	2000939	NSAS-2P891
	<b>Fuses</b>	
QF101, QF102	252112	△ ICPN15, IC protector<G>

NOTE: <G>:Only 220V / 240V / Worldwide models

### OPTO./DIGITAL OUTPUT PC BOARD(NADG-3364-1)

CIRCUIT NO.	PART NO.	DESCRIPTION
Q191	24120014	DF-1111/T, Photo coupler
P191	25045239	NPJ-1PORG-113, Terminal, Opto. output
P192	25045172	HSJ1003-01-020, Terminal RI
SC191	2000929	NSAS-12P882, Socket

### DISPLAY CIRCUIT PC BOARD(NADIS-3365-1)

CIRCUIT NO.	PART NO.	DESCRIPTION
	<b>ICs</b>	
Q701	22240179	CXP5058H-104OZ
Q703	22240173	LC6527H-3722
Q707	222963	LB1630
	<b>Fluorescent tube</b>	
Q702	212059	16BT-09GK
	<b>Transistors</b>	
Q704, Q705	2212600	DTA124ES
Q706	2212132 or 2212133	2SC2021-R or 2SC2021-S
	<b>Diodes</b>	
D701-D704	223163	1SS133
D705	224650562 or 224450562	HZ5.6EB2 or MTZ5.6B
	<b>Capacitors</b>	
C701, C703	354721019	100 $\mu$ F, 6.3V, Elect.
	<b>Resistors</b>	
R735-R742	49163472408	4.7kohm $\times$ 8, 1/10W, Network
	<b>Switches</b>	
S701-S736	25035548	NPS-111-S510
	<b>Sockets</b>	
SC701	2000891	NSAS-26P847
SC702	2000883	NSAS-18P839
SC703	2000732	NSAS-4P688
SC704	2000755	NSAS-4P711
SC705	2000892	NSAS-12P848

CIRCUIT NO.	PART NO.	DESCRIPTION
	<b>Holder</b>	
	27190656A	Display

### POWER SWITCH PC BOARD(NAPS-3366-1)

CIRCUIT NO.	PART NO.	DESCRIPTION
C941	3500065A	△ DE7150FZ103PCSA, Capacitor IS
P941	25035558	△ NPS-111-L520P, Power switch

### HEADPHONE AMPLIFIER PC BOARD(NAAF-3367-1)

CIRCUIT NO.	PART NO.	DESCRIPTION
Q451	222887	NJM4556S, IC
Q453, Q454	2211705 or 2211706	2SD655-E or 2SD655-F, Transistors
C453, C454	354742219	220 $\mu$ F, 16V, Elect. capacitors
C455, C456	371122224	2200pF $\pm$ 5%, 50V, Mylar capacitors
C457, C458	354744709	47 $\mu$ F, 16V, Elect. capacitors
R451	5104242	N16RGM20KB30F, Variable resistor
R463, R464	442521014	100ohm, 1/2W, Metal oxide film resistors
P451	25055183	NPLG-2P167, Plug
SC451	2000917	NSAS-16P870, Socket

### HEADPHONE TERMINAL PC BOARD(NAAF-3368-1)

CIRCUIT NO.	PART NO.	DESCRIPTION
P491	25045139	HLJ0540-01-010, Headphone terminal

### SWITCH PC BOARD(NASW-3369-1)

CIRCUIT NO.	PART NO.	DESCRIPTION
U751	241068	BX-1407, IC
D751, D752	225142	SEL2913K, LEDs
C751	354721019	100 $\mu$ F, 6.3V, Elect. capacitor
S751	25065325	NSS-23128, Slide switch
S752-S755	25035548	NPS-111-S510, Push switches
P701	25055187	NPLG-6P171, Plug
	27190499A	Holder

### TERMINAL PC BOARD(NAETC-3359-1)

CIRCUIT NO.	PART NO.	DESCRIPTION
P001	25050361	NSCT-18P188, Socket
SC001	2000890	NSAS-12P846, Socket
SC002	2000873	NSAS-18P829, Socket

NOTE: THE COMPONENTS IDENTIFIED BY MARK △ ARE CRITICAL FOR RISK OF FIRE AND ELECTRIC SHOCK. REPLACE ONLY WITH PART NUMBER SPECIFIED.

